

# Direct measurements and numerical simulations issues in airport air quality

Francisc Popescu, Ioana Ionel, Livio Belegante, Nicolae Lontis, and Viorica Cebucean

**Abstract**— The paper highlights how numerical simulations applied as pollution dispersion modeling in airport areas is a reliable solution in solving complex problems concerning air quality situations and status of strategies or perspectives for sustainable urban development where traffic areas can be included. The article reveals a methodology used to evaluate the concentration of major pollutant species within an international airport environment, using mathematical analysis, and informs about the validation possibilities of the results and tool by direct measurements. The software tool ISC3View used in this scientific paper has a global acceptance and approval by all the scientific community in the matter of air quality. The software was developed in the United States by the Environmental Agency. In the article, a case study is presented for the International Airport from Timisoara, consisting from different representative episodes of several days in the year 2008 and 2009. The study is making a short introduction of the general air pollution issues and the fleet functioning as emission factors.

**Keywords**— air quality, environment, pollutant dispersion.

## I. INTRODUCTION

AIR pollution is a major concern for all nations, with a higher or lower development level. The rapid increase of the industry sector and urban development had generated substantial quantities of substances and poisonous materials, which are, mostly evacuated in the atmosphere, in addition the traffic and mobility necessity determined the developing of infrastructures that allow the different fleet, mostly equipped with internal combustion engines, to act. The human society is not recognizing that the environment has only a limited capacity to process all its waste, without major changes. Each of us is a polluter but also a victim of pollution.

Interests in aircraft and airport air pollutant emissions have been rising since the substantial increase in commercial turbojet traffic in the 1970's. Aircraft emissions produce air contaminants such as NO<sub>x</sub>, HC, and fine particulate matter (PM), which in turn can become involved in broader environmental issues related to ground level ozone (O<sub>3</sub>), acid rain, climate change, and present potential risks relating to public health and the environment. Unlike most transportation modes, aircraft travels great distances at a variety of altitudes,

generating emissions that have the potential to impact air quality in the local, regional and global environments.

Airport-related activities result in the emission of a host of air pollutants that adversely affect public health and the environment, including nitrogen oxides (NO<sub>x</sub>), hydrocarbons (HC), particulate (PM), carbon monoxide (CO), and toxics. NO<sub>x</sub> and HC are precursor emissions of ground-level ozone, which causes lung irritation and aggravates diseases such as asthma, chronic bronchitis, and emphysema. Worldwide, the number of aircraft operations (defined as one takeoff or one landing) has grown substantially from around 15 million in 1976 to almost 30 million in 2000 (for USA only), a cumulative growth of about 105 percent. While emissions from most source sectors are declining due to the implementation of more stringent control programs, the growth in air travel [1] and the continued lack of control programs for aircraft engines is resulting in increased pollution from airports.

Significant improvements have been made over the past two decades regarding aircraft fuel efficiency and other technical improvements to reduce emissions. However, these advancements may be offset in the future by the forecasted growth of airport operations and other aviation activities. Because aircraft are only one of several sources of emissions at an airport, it is also considered essential to effectively manage emissions from terminal, maintenance and heating facilities; airport ground service equipments; and various ground transport traveling around, to and from airports. Optimizing airport design, layout and infrastructure; modifying operating practices for greater efficiencies; retrofitting the GSE fleet to “no-“ or “low-“ emitting technologies; and promoting other environmentally-friendly modes of ground transport are some of the current opportunities airports and the rest of the aviation industry can adopt or apply to help meet these goals and encourage sustainable development in commercial air transportation.

Recent health effects studies have shown an association between existing levels of fine particles (size, concentration) and health effects such as increased respiratory illness, cardio-pulmonary morbidity, and premature mortality. For example, a link between air pollution and mortality was demonstrated in two studies using data collected by the American Cancer Society [2]. The study tracked over 500,000 adults in 51 cities over an 8-year period. The adjusted risk of mortality in cities with the highest levels of fine particulate pollution was approximately 15 to 25 percent higher than in cities with the lowest particulate levels. A follow-up analysis determined that each 10 microgram elevation in fine particulate air pollution

was associated with an increase of approximately 8 percent in lung cancer mortality and a 6 percent increase in cardiopulmonary mortality. [3]

According to estimates of the Intergovernmental Panel on Climate Change (IPCC), international aviation contributes about 3.5 % to global warming, through the emitted pollutants. International aviation is therefore becoming increasingly responsible for the greenhouse effect and pollutants emissions as well, but is nevertheless not covered yet by the Kyoto Protocol. In contrast to international aviation, greenhouse gas emissions of national aviation are included in the Kyoto Protocol. Fuels used in international air and maritime traffic – so-called bunker fuels – are excluded from reduction and stabilization commitments for the first commitment period (2008 - 2012), because agreement could not be reached on the question of the assignment of such emissions. A range of policies and measures are currently being discussed at a national and international level, in order to comply with commitments arising from Article 2.2 of the Kyoto Protocol. [4] Besides technical standards for the limitation of greenhouse gas emissions, proposals primarily cover economic instruments, such as taxes and levies for the internalization of greenhouse gas emissions as well as voluntary agreements with the aviation industry. Introduction of an emissions trading system for international aviation is also being discussed. [4] Beyond that, in major airports from all developed European countries strict regulation and continuous air pollution monitoring stations are deployed for more than a decade, in developing countries there is no control of air pollution in airports or their vicinity. For example, Romanian national air quality monitoring network consists of 117 automated stations but none in or near major airports.

Transportation systems, that plays an essential role in economic and social development as well as in the creation of wealth and standards for our modern societies in development or transition, ensures access to jobs, housing, goods and services and answer to the need of people for mobility. However, the continuing expansion of air transport raises serious concerns about long-term sustainability of the industry; even presently huge discussions are revealing that aviation is less polluting than ground vehicles mobility, related to a minimum number of passengers and longer distances. According to IATA, European passenger air traffic more than doubled during the 1985 – 1998 period (an average growth of almost 7% a year) and the overall demand is expected to continue to rise. Additionally it is forecasted by EUROCONTROL that the number of flight in Europe 2025 will be between 1.6 and 2.1 times the traffic of 2003, up to 17 millions flights in the case of a fast growth scenario [6].

As a consequence, environmental issues became serious constraints for the growth of the industry and the capacity.

## II. METHODOLOGY AND DATA INPUT

To evaluate the impact of anthropogenic pollution of atmosphere two methods can be used: direct measurements of pollutants concentrations at the site and numerical evaluation

of dispersed emitted air pollutants based on mathematical and chemical equations. Many types of related software exist but only several of them have global coverage and acceptance. Two of them are used intensively, ISC3View developed by United States Environmental Protection Agency (US-EPA) and AUSTAL2000, developed by German Federal Environment Agency (UBA) in the frames of UFOPLAN project 200 43 256 and is in compliance with the German guideline VDI 3945 Part 3 and Appendix 3 of the TA Luft.

For an airport the first step for conducting an air quality study consists in producing an emissions inventory. In general term, emissions inventories provide the total amount of pollutants generated from defined emission sources, for a selected period. Airport air pollution does not depend only on aircraft movements in the air and on the ground, and weather, as in specific cases the turn of wind direction determines modification of the landing/staring directions. Other sources of pollution are important; as the engines of the airplanes, the emissions from airport induced road traffic, the ground support equipment (e.g. Belt Loaders, Passenger Coaches, Auxiliary Power Units, etc.) and stationary sources (e.g. fuel tanks, maintenance equipment, etc). However most of the airports only conduct very basic inventories (total emissions per year). Only few airports perform detailed emissions inventories, even though they are necessary prior to any dispersion modeling. One of the underlying reasons is the lack of a harmonized pan-European methodology. [7] It is critical to bear in mind that all airport emissions sources should be accounted in the modeling process. That is because the inventory must provide a complete picture of the emissions, especially if a dispersion model is to be applied. Finally, such airport models can be used to test future emission scenarios and therefore are important tools for decision making when dealing with environmental concerns.

In this study the emission factors were selected from a database [8] for ground transportation fleet, airport heating plant and aircraft characteristic fleet generated by EMEP/EEA air pollutant emission inventory guidebook 2009 [8], an European emission factor database.

The scenario was built on the assumption of full air traffic load in the airport and at 50 % occupation of the airport car-parking facility. Thus the episodes considered were based on different simultaneously acting sources in the area meaning 10 aircrafts, applying the LTO cycle, all airport ground vehicles, public parking lot with 250 vehicles (smaller than 3.5 tones) and the local small size power plant was considered at nominal load, as well.

The airport has two public parking spaces with a total capacity of 514 parking lots. In the dispersion study the traffic in the parking lots was considered at 257 vehicles per hour. For those vehicles a global emission factor was considered, corresponding to 30% diesel and 70% petrol engines. The Emission factors from the airport heating plant (Wiessman Vitoplex 1120 kW). The heating plant has a 20 meters high stack with an inner diameter of 0.7 meters. The input data in simulation was that the exhausted flue gases have a temperature of 68 °C and the speed of 0.5 m/s.

With those data as an input the simulation for selected air pollutants was conducted on ISC3View dedicated software

that uses Gaussian plume air dispersion model with AMS/EPA Regulatory Model (AERMOD), an air dispersion model based on planetary boundary layer theory. AERMOD fully incorporates building downwash algorithms, advanced depositional parameters, local terrain effects, and advanced meteorological turbulence calculations. The software is applicable to a wide range of buoyant or neutrally buoyant emissions up to a range of 50km and is suitable for complex terrain and urban dispersion scenarios.

### III. RESULTS

From the Romanian perspective it is the first time that research in this area has been done, especially direct in-situ monitoring of relevant air pollutants. The impact of Romanian airports on the air quality is basically unknown; the Romanian National Air Quality Monitoring Network is still in a development phase and is not covering airports' vicinity.

The direct measurements have been done in a large regional airport, located in the west side of Romania. Major air pollutants have been measured in field campaigns in 2008 and 2009. For the measurements two mobile laboratories were used, equipped with reference instruments, meteorological instruments and open path instruments. Both laboratories have been placed near airport apron.

The experimental setup consists in two mobile air quality monitoring laboratories, one from University Politehnica of Timisoara (UPT) and one from National Institute of R&D for Optoelectronics (INOE). Each laboratory is equipped with reference point instruments for major pollutants ( $\text{SO}_2$ ,  $\text{O}_3$ ,  $\text{NO}_x$ ,  $\text{CO}$ ,  $\text{CH}_4$ , NMHC, THC and PM10), HORIBA AP370 type instruments and two DOAS instruments. The path of the DOAS instruments was set up along with airport taxing lane and one DOAS path length was 60 meters and the other  $\sim 300$  meters, oriented in the same direction (figure 1). Meteorological sensors (wind speed and direction, air temperature, pressure and humidity) are mounted around the mobile laboratories. The following pollutants have been continuously measured, with 10 second resolution, over the entire measuring episode with high precision equipment [3]:

- $\text{SO}_2$  measured with two Horiba APSA370 instruments, measurement principle is UV fluorescence, reference method: EN 14212:2005. The combined measurement uncertainty is  $U = 1.76\%$  for recorded values;

- $\text{NO}$ ,  $\text{NO}_2$  and  $\text{NO}_x$  measured with two Horiba APNA370 instruments, measurement principle is chemiluminescences, reference method: EN 14211:2005. The combined measurement uncertainty is  $U = 2.06\%$  for recorded values;

- $\text{O}_3$  measured with two Horiba APOA370 instruments, measurement principle is UV photometry, reference method: EN 14625:2005. The combined measurement uncertainty is  $U = 6.98\%$  for recorded values;

- $\text{CO}$  measured with two Horiba APMA370 instruments, measurement principle is NDIR (Non Dispersive Infrared), reference method EN 14626:2005. The combined measurement uncertainty is  $U = 4\%$  for recorded values;

- $\text{CH}_4$ , NMHC and THC measured with two Horiba APHA370 instruments, measurement principle is FID (flame ionization detection), reference method EN 12619:2002. The combined measurement uncertainty is  $U = 0.9\%$  for recorded values;

- Other gases have been measured with DOAS instruments.

The detailed flights schedule was obtained; all international and national/regional flights are counted. In addition, due to the summer period, all charter flights to/from Greek Islands have been considered.

The work related to direct monitoring of air pollutants was published in detail [12]; a view of the results is given in figures 2 and 3. Fig. 2 shows the carbon monoxide CO recorded values, measured with 3 different instruments: two reference NDIR point measurement instruments and one DOAS-IR Siemens-Hawk instrument. A very good correlation of the measured values can be observed, especially for the CO-UPT and CO-DOAS instruments. The different methods used for CO measurements have given same result; the high concentration recorded values and background concentration values are similar for point and open path instruments. The CO-INOE measurements are in the same trend but the measured values are with  $\sim 0.4 \text{ mg/m}^3_{\text{N}}$  lower than the other instruments (figure 2). This could be caused by an error in span gas calibration. On top of the figure 2 are drafted the departures and arrivals of national/regional, international and charters corroborated with the carbon monoxide measured values. The dependency between aircraft traffic on the apron and the CO measured values is visible in figure 1, the higher values for CO have only been recorded during the departure or landing of the aircrafts. However, figure 2 is important because it shows that the selected placement of the mobile air laboratories near airport facilities and apron is ideal and the measured values can be considered representatives for the airport facilities surroundings.

In fig 1 an overview of the schematic of the mobile laboratory is given.

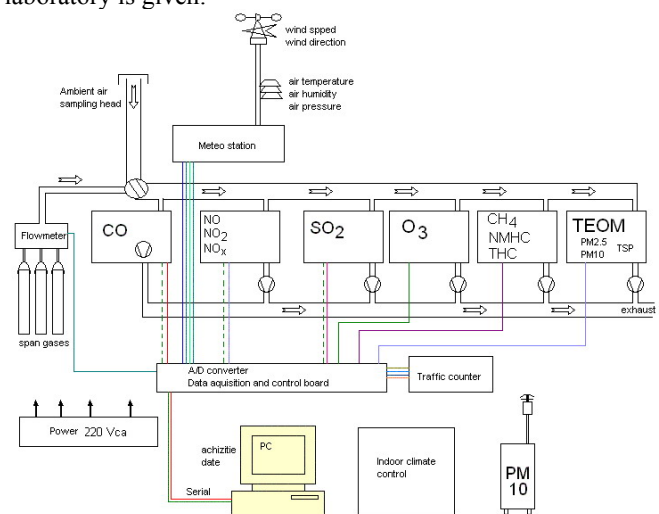

Fig. 1 An overview of the operational schematic of the monitoring station

The measured values for carbon monoxide are much lower than the  $10 \text{ mg/m}^3_{\text{N}}$  limit value, regulated by 2000/69/EC Directive. The measured values are normal because the airport location is away from the city or any road and the only CO source is represented by the aircrafts.

During the measurements a serious concern was given by the recorded values for NMHC, an example of recorded values is given in fig 3. The values recorded for volatile organic compounds are up to  $3 \text{ mg/m}^3_{\text{N}}$  in periods with high airplane traffic. These values are representing a serious concern for the passenger health, knowing that some of these volatile compounds (like benzene) are causing cancer [8]. VOCs include a variety of chemicals, some of which may have short- and long-term adverse health effects. Key signs or symptoms associated with exposure to VOCs include conjunctival irritation, nose and throat discomfort, headache, allergic skin reaction, dyspnea, declines in serum cholinesterase levels, nausea, emesis, epistaxis, fatigue, dizziness. As with other pollutants, the extent and nature of the health effect will depend on many factors including level of exposure and length of time exposed. The limit value regulated by 2000/69/EC Directive for benzene is  $5 \text{ } \mu\text{g/m}^3_{\text{N}}$  and the measured values for VOCs are up to  $3 \text{ mg/m}^3_{\text{N}}$  ( $3000 \text{ } \mu\text{g/m}^3_{\text{N}}$ )! These values appear not only during airplanes departure or arrivals but mostly when the airplanes are fueling.

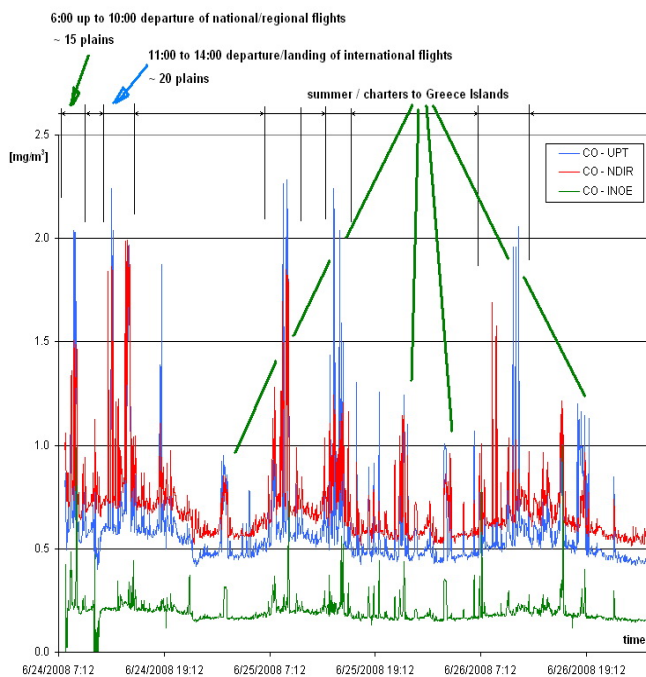

Fig. 2 View (explanatory) of the results obtained thru direct measurements, CO concentration and airplanes traffic.

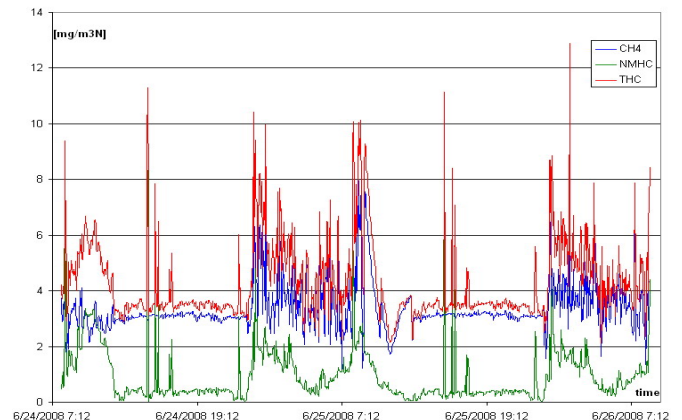

Fig. 3 View (explanatory) of the results obtained thru direct measurements, CH4, NMHC and THC concentrations.

In this work we concentrate not on the direct measurements conducted but in the evaluation of the air quality in airport area by means of numerical simulation, based on calculated emission factor but also on emission factors from European databases.

In the simulation the local appropriate meteorological data for the considered episode, were used. In figure 4 a wind rose is generated, as resulted from applying the WRPLOT software. The main data input are wind speed and direction, air temperature, humidity and pressure.

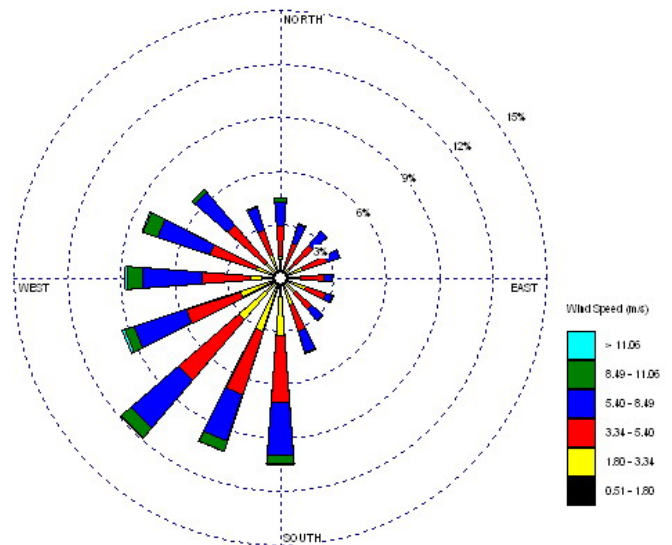

Fig. 4 Wind rose for the selected simulated episode

With those data as an input the simulation for selected air pollutants was conducted on ISC3View dedicated software that uses Gaussian plume air dispersion model with AMS/EPA Regulatory Model (AERMOD), an air dispersion model based on planetary boundary layer theory. AERMOD fully incorporates building downwash algorithms, advanced depositional parameters, local terrain effects, and advanced meteorological turbulence calculations. The software is applicable to a wide range of buoyant or neutrally buoyant emissions up to a range of 50km and is suitable for complex terrain and urban dispersion scenarios.

In fig. 5 to 9, the resulted izo-concentration curves of dispersed pollutant concentrations are presented, with hourly and daily mean values. In this dispersion study an area of 1 km<sup>2</sup> was considered, with the airport in the center of the bi-dimensional coordination system.



Fig. 5 CO concentration and dispersion, hourly mean values

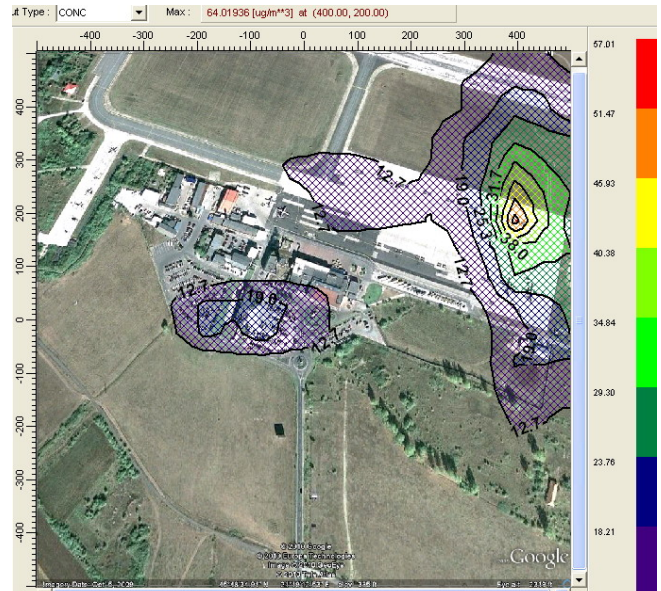

Fig. 7 NOx concentration and dispersion, daily mean values

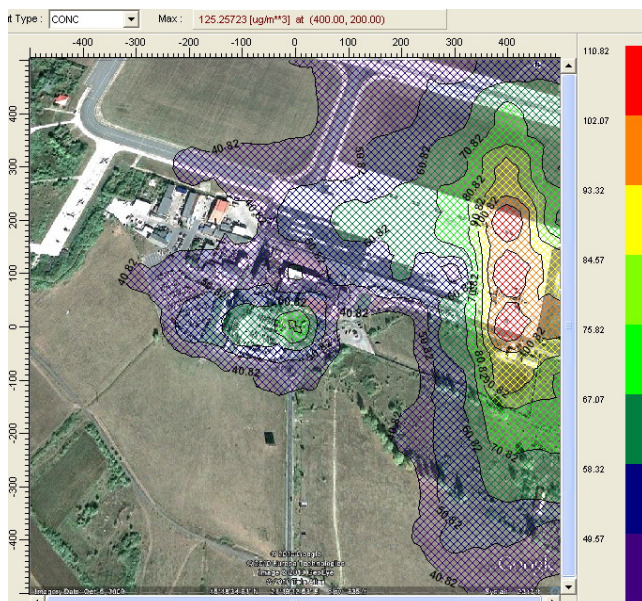

Fig. 6 NOx concentration and dispersion, hourly mean values

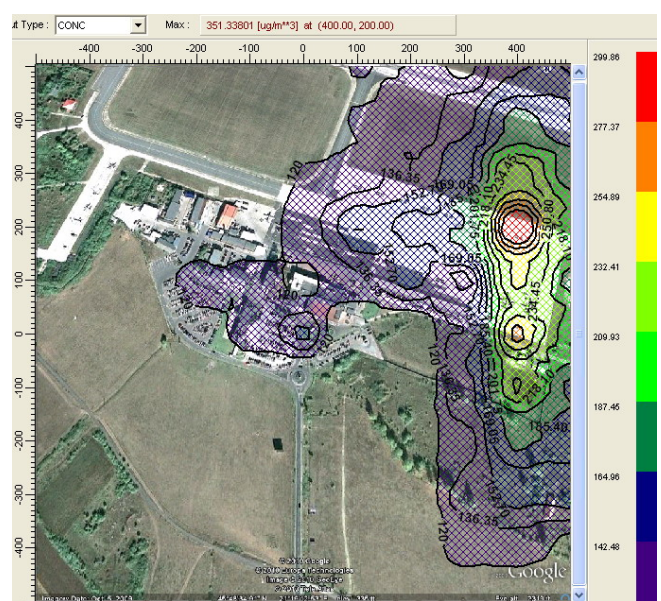

Fig. 8 NMVOC concentration and dispersion, hourly mean values

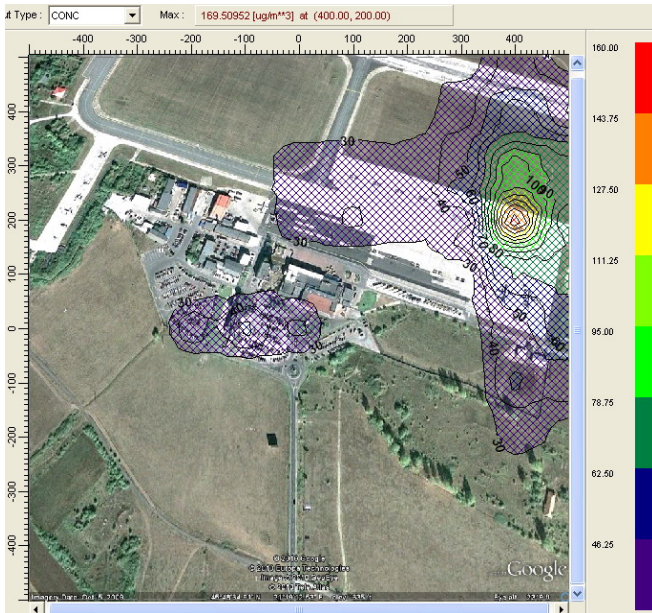

Fig. 9 NMVOC concentration and dispersion, hourly mean values

In table 1 the maximum values obtained after simulation episodes are given in relation with direct measurements, only maximum values for related pollutant concentration are given.

Table 1 Comparison of the maximum values obtained by simulation versus direct measurements

Pollutant / unit	Maximum of one hour mean values for pollutant concentration	
	Simulation (calculated values)	direct measurements
CO [mg/m <sup>3</sup> ]	1.96	1.83
NO <sub>x</sub> [µg/m <sup>3</sup> ]	125.25	110.7
COV [mg/m <sup>3</sup> ]	0.351	1.5

The direct measurements of air pollution were achieved under RADO (Romanian Atmospheric Research 3D Observatory) project activities as parallel in-situ measurements of pollutants concentration in air were achieved, by two mobile laboratories in Traian Vuia International airport. Details are given in [9],[10] In figure 7 a view of the mobile laboratories location is given.



Fig. 7 View of the mobile laboratories location in the airport area

As it results from the comparative table, for CO and NO<sub>x</sub> simulated values one can conclude that they values are of

same range and very close to the on line measured concentrations. More than that, the locations where by simulation the installation of the maximum values occurs is almost identically or very close to the location where the monitoring laboratories have been installed, near the apron. This demonstrated not only the correct positioning of the devices, in an most probable polluted spot, but also that the equipments are correct working, and the input data for the considered episode analyzed by dispersion were correctly designed. The correlation is no longer valid for NMVOC concentration, possible because in the simulation scenario the fugitive emissions of NMVOC from aircrafts fueling where not included. A database for NMVOC fugitive emissions for aircraft fueling is not yet implemented. Another cause for this discrepancy can be the presence of other NMVOC emission sources in the vicinity of the airport. It is also possible that the EMEP database emission factor for NMVOC is underestimated, recent studies [11] showing that the aircraft emissions of NMVOC are up to 10.4 mg/kg fuel burnt, a median distribution of the NMVOC classes is presented in figure 8, data obtained through the PartEmiss project. [11]

total NMVOC EI: 10.4 [mg/ kg fuel burnt]

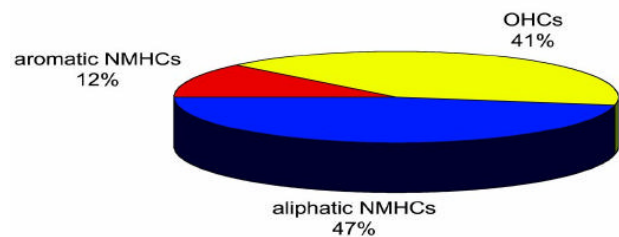

Fig. 10 Median distribution of the NMVOC classes [mg/kg fuel burnt] [11]

The “hot-spots” observed in figures 5 to 9 are in the airport apron area, where airplanes are taxiing and refueling. Hot-spots of concentrations can also be observed on the airport single track line. Another sensitive area is the public parking place, especially for CO and NO<sub>x</sub> emissions.

#### IV. CONCLUSION

This paper brings in attention an example of possible strategy in order to meet the general EU strategy concerning the air quality issues in urban areas. Also, gives an example on how numerical simulations with software approved by international institutions can be used by local urban and environment authorities in order to control pollutants emissions in urban areas, with an emphasis on sustainable and eco-friendly urban development. The advantage of numerical simulations is given by fast results, low cost and possibility to evaluate different pollution reduction scenarios. [15]

This study has achieved its goals and created a basic understanding for the local air quality domain about aircraft and airport emissions contribution. However, this preliminary study may not have covered all the possible scenarios and the results presented are a preliminary qualitative analysis of dispersion simulation results.

Overall, this study provides an estimation of how dispersion analysis can be performed for an airport. Also highlighted are the need for improvements and the areas requiring further attention for a better understanding of the concepts involved.

Aircraft emissions of CO and HC tend to be particularly high during taxi-in and taxi-out, when aircraft engines are operating at less than maximum efficiency. Hence, operational changes that reduce aircraft idling and taxi time can directly reduce pollutant emissions. A variety of options exist for reducing taxi time. [14] For example, so-called “dispatch towing” – especially with high-speed tugs – can be used to move aircraft between the terminal gate and runway more efficiently and with fewer frequent stops than with standard practices. Since taxi-out time tends to be longer than taxi-in time, this option is likely to be most feasible on departing flights. Potential emissions benefits for this option are somewhat offset by additional emissions from the tow tug engine (unless it is electric powered) and from continued operation of the aircraft’s APU for ventilation and electricity during towing. Taxi time can also be reduced by airport designs that allow planes to stay close to runways between landing and takeoff. This can be accomplished by decentralized gate designs wherein passengers are brought to and from the aircraft by other transport vehicles. Again, the resulting reduction in aircraft emissions would be somewhat offset by increased emissions from ground passenger transport vehicles.

Aviation contributes significantly to emissions of greenhouse gases. Currently, the airports emissions of are about 3% [60] of the total emissions of greenhouse gases in the EU. The rapid growth of aviation emissions contrasts with the successes of many other sectors of the economy on emission reduction.

Aviation stimulates the economy, trade and tourism, generating new business opportunities and enhances the potential to improve quality of life, both in developed regions and the ongoing development.

Introduction and procedures focusing on efficient management of air traffic in and around the airport may limit the amount of fuel consumed during the takeoff phase, landing and rolling. By using higher-capacity aircraft it is possible to create a much efficient use of airport infrastructure and ground facilities.

The aviation industry has exceeded over the years, most other industries are reducing noise and emissions per unit produced. Every year the fuel efficiency is increased with about 1-2% per year and emissions are reduced with 2% of the total. The aviation industry is growing by 5% per year and achieved efficiency savings are up to 1.5%. However, it is estimated that air traffic will grow faster than both, so technological improvements will not be enough to solve this problem.

Rail connection to airport should be encouraged, thus introducing sustainable transport options ecologically to reach the airport, in this regard is crucial to have bus and train extensions. Airports should encourage use of environmentally friendly cars, using different price for parking and offering preferential parking spaces for them. On airport service vehicles should at least use less polluting energy sources such

as gas and electricity. Currently, several types of vehicles are operating on electricity provided from a battery. This alternative should be considered, and the implementation should depend on the specific operational requirements. Transport personnel to and from airport can generate significant traffic, alternative options should be encouraged, as staff buses, car sharing programs, that work with different starting hours to avoid peak hours, and if possible, use of bicycles by airport staff.

Airport design could play a positive role in reducing emissions, especially if it means running redesign and boarding-disembarking platforms to reduce congestion at airports. When designing terminals, the energy consumption through heating and air conditioning and to consider using solar panels there, it is a possibility

Due to the variety of emissions sources at airports, policymakers must consider control strategies for various types of equipment, operations, and functions. Cost-effective technical and operational options are available to reduce emissions from all airport sources. Of course, some options are more cost effective and easier to implement than others. The cost-effectiveness and feasibility of the different measures can vary from airport to airport. To take one example, installing electrified gates can be done more easily at newer airports than at older airports. [17] In addition, consideration needs to be given to potential trade-offs as some technologies can lead to decreases in one pollutant at the expense of another. These complexities need not stand in the way of action, but they do argue for a careful and comprehensive evaluation of all available options.

A variety of options exist to reduce emissions from ground service equipments. These include the use of alternative fuels, [13] electric equipment and emissions control retrofits.

Operational measures to reduce aircraft engine emissions,, such as single engine taxi and reduce use of reverse thrust, can generally be undertaken at little cost, though safety considerations, pilot training and airport design may affect with generated improvements, the applicability of these measures, in individual situations. Operational practices of this type are already encouraged by many airlines; hence the remaining potential to reduce emissions using operational strategies is uncertain. [16]

As a consequence EUROCONTROL initiated the ALAQS (Airport Local Air Quality Studies) project which addresses strategic, methodological and practical issues surrounding air quality assessment around airports. The project will provide to airports and practitioners the ‘best practice’ emissions inventory and dispersion modeling methods, guidelines and a supporting toolset that can be applied at Pan-European level.

The main conclusion of the study was that numerical simulation as a tool is useful in studies regarding air pollution control in airport area but with some limitations given by the high uncertainties introduced by the emission factors, that in some cases (like VOC’s) can be underestimated. However, the numerical simulations are proven efficient if so called “classical” pollutants like CO, NO<sub>x</sub> or SO<sub>2</sub> are the subject of the study.

## ACKNOWLEDGMENT

This study was accomplished in the frame of Romanian Atmospheric Research 3D Observatory (RADO), Ref no: STVES – 2008/115266 with the financial support of Norwegian Cooperation Programme.

## REFERENCES

- [1] Report of the FESG/CAEP/6 traffic and fleet forecast (Forecasting subgroup of FESG), CAEP paper CAEP-SG20031-IP/8, 2003
- [2] C.A. III Pope., M.J. Thun, M.M. Namboodiri, D.W. Dockery, J.S. Evans, F.E. Speizer and C.W. Jr. Heath, "Particulate air pollution as a predictor of mortality in a prospective study of US adults", *American Journal of Respiratory Critical Care Medicine*, 151:669-674, 1995
- [3] Pope CA III, R.T. Burnet, M.J. Thun, E.E. Calle, D. Krewski, K. Ito and G.D. Thurston, "Lung cancer, cardiopulmonary mortality, and long-term exposure to fine particulate air pollution", *Journal of the American Medical Association*, Vol. 287 No. 9, March, 2002
- [4] Cames M. and Deuber O., *Emission trading in international civil aviation*, Öko-Institut e.V., Institute for Applied Ecology, Berlin, 2009
- [5] Popescu Fr., et al., "Air Quality Monitoring in the City of Timisoara. First steps and perspectives.", *Journal of Environmental Protection and Ecology*, Vol. 10, 2009, 1-13
- [6] EEC, *Long Term Forecast of Flights (2004-2025)*, Eurocontrol Statistics & Forecast Services, Brussels, 2004
- [7] A. Celikel, N. Buchene, I. Fuller, E. Fleuti and P. Hofmann, *Airport local air quality modeling: Zurich airport emissions inventory using three methodologies*, European Organization for the Safety of Air Navigation EUROCONTROL, 2004
- [8] EEA, *EMEP/EEA air pollutant emission inventory guidebook 2009*, Technical report no.9/2009, ISBN 978-92-9213-034-3, ISSN 1725-2237, DOI 10.2800/23924, © EEA, Copenhagen, 2009
- [9] I. Ionel, G. Apostol, F. Popescu, C. Talianu and M. Apascaritei, "Air quality monitoring in an international Romanian airport", *Journal of Environmental Protection and Ecology*, accepted for publication, 2010
- [10] I. Ionel, N. Doina, F. Popescu, C. Talianu, L. Belegante and G. Apostol, "Measuring air pollutants in an international Romanian airport with point and open path instruments", *Optoelectronic Techniques for Environmental Monitoring Conference – OTEM 2009*, 30th September – 2th October, Bucharest, 2009, pp. 72-76
- [11] R. Kurtenbach, M. Kapernaum, J. Lorzer, A. Niedojadlo, M. Petrea, C. Wahl and P. Wiesen, "Emission of Non-Methane Volatile Organic Compounds (NMVOCs) from a Jet Engine Combustor and a Hot End Simulator (HES) During the PartEmis Project", *Proceedings of the European Conference on Aviation, Atmosphere and Climate (AAC)*, June 30 to July 3, 2003, Friedrichshafen, Germany, pp. 52-58
- [12] I. Ionel, D. Nicolae, F. Popescu, C. Talianu, L. Belegante and G. Apostol, "Measuring Air pollutants in an international Romanian airport with point and open path instruments", *Romanian Journal of Physics*, accepted for publication in 2010, [http://www.nipne.ro/rjp/accepted\\_papers.html](http://www.nipne.ro/rjp/accepted_papers.html)
- [13] F. Popescu, I. Ionel and N. Lontis, "Waste animal fats as renewable and friendly environmental energy resource", *WSEAS Transactions on Environment and Development*, issue 7, Vol. 6, pp. 489-498, 2010
- [14] G. Trif-Tordai, I. Ionel and F. Popescu, "Novel RES based co-combustion technology", *WSEAS Transactions on Environment and Development*, issue 7, Vol. 6, pp. 561-570, 2010
- [15] L.T. Silva, F.G. Mendes and A.R. Ramos, "Urban air dispersion model in a mid-sized city. Validation methodology", *WSEAS Transactions on Environment and Development*, issue 1, Vol. 6, pp. 1-10, 2010
- [16] M. Apascaritei, Popescu F. and I. Ionel, "Air pollution level in urban region of Bucharest and in rural region", *Proceedings of the 11th WSEAS International Conference on Sustainability in Science Engineering*, Timisoara, Vol.2, 2009, pp. 330 – 335
- [17] I. Ionel, F. Popescu, N. Lontis, G. Trif-Tordai and W. Russ, "Co-combustion of fossil fuel with bio fuel in small cogeneration systems, between necessity and achievements", *Proceedings of the 11th WSEAS International Conference on Sustainability in Science Engineering*, Timisoara, Vol.2, 2009, pp. 352-357.